



NPO

OPEN IMPELLER ALL STAINLESS STEEL END SUCTION PUMPS

PRODUCT TRAINING MANUAL



NPO PRODUCT INTRODUCTION

WASHER SERVICE APPLICATIONS

TABLE OF CONTENTS

| | |
|--|----|
| Introduction | 4 |
| Product Overview | 6 |
| Major Components | 7 |
| NPO Product Line Numbering System | 8 |
| Common NPO Catalog Models | 9 |
| Components and Materials of Construction | 10 |
| Performance | 11 |
| Dishwasher Market - Primary Applications | 15 |
| – Chemical Companies | 16 |
| – Restaurant Supply | 16 |
| – Typical Dishwasher Design | 17 |
| Commercial Laundry | 18 |
| Parts Washers | 19 |
| Machine Tool Coolant | 20 |
| Competition | |
| – Advantages of the NPO Over Flowserve (IDP) | 21 |
| – Commercial Laundry | 21 |
| – Parts Washer and Machine Tool | 21 |
| Installation Procedures | 22 |
| Service and Maintenance Procedures | 24 |
| Troubleshooting | 26 |

INTRODUCTION

This manual is designed to teach you, the Goulds Water Technology distributor, about the NPO end-suction open impeller pump. If you are a salesman, serviceman, technician, application engineer or even the owner at a Goulds Water Technology distributorship, this manual is for you. It is not intended for the pump purchaser or user.

In this manual, you will find detailed information on product specifications and capabilities, where to sell it, how to install it and how to repair it. This is meant to supplement the introduction meeting held by your Goulds Water Technology factory representative, and to be a permanent reference source. In this way, it can be used as an in-depth backup to your Goulds Water Technology catalog materials.

Why the NPO?

The NPO (or open impeller NPE) was developed as a result of Goulds Water Technology experience with the commercial dishwasher market. In addition, it builds on the strength of our NPE market presence and allows us to enter other high volume markets where small solids or particulate handling is required. The exclusive Goulds Water Technology fabricated stainless design also offers considerable advantages over our major competitors in these markets.

What is the Market Size?

The U.S. market for commercial dishwashers is approximately 20,000 units per year. In addition, commercial laundry systems account for another 3,000 systems with up to ten pumps per line. NPO applications in parts washing, particulate and machine tool markets add another 15,000 units per year. Similar applications exist around the world.

INTRODUCTION

What is the Performance Coverage?

The NPO performance range is from 10 to 80 GPM at 250 to 110 feet of head. This fits the requirements of most small spray washer systems such as commercial dishwashers.

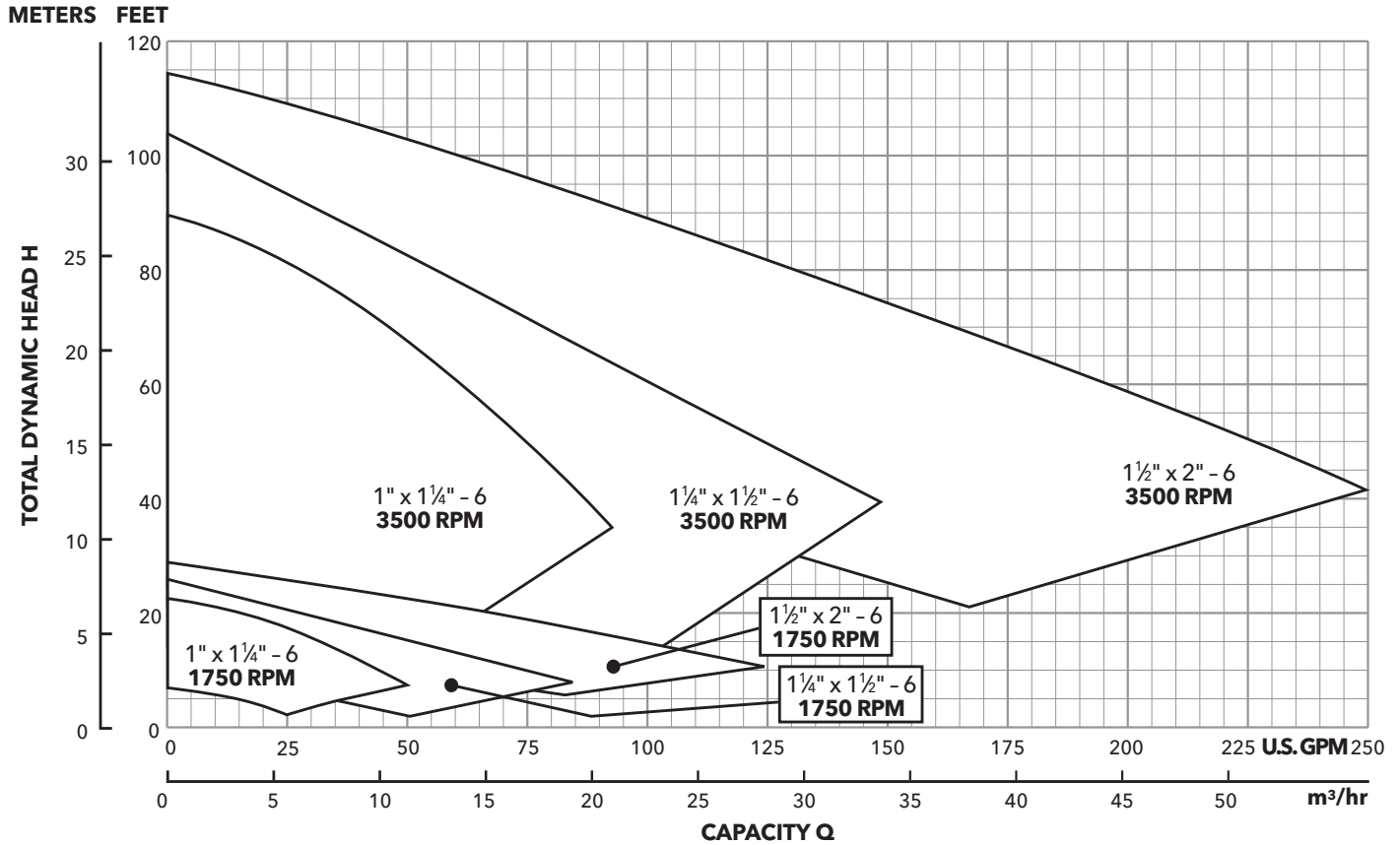

PRODUCT OVERVIEW

The NPO pump from Goulds Water Technology is an open impeller, single stage, end suction centrifugal made of 316 stainless steel for a variety of commercial washing applications

It consists of three pump sizes using $\frac{1}{2}$ - $7\frac{1}{2}$ HP motors in a variety of enclosures. Many of the options for the NPE including seals and the vent/flush accessory are also available for the NPO.

The casing is a modification of the NPE casing which incorporates a flat running surface for the front of the open impeller. The impeller for the smallest size is a cast 316 open design similar to that used in the ICS. Impellers for the two larger sizes are fabricated 316L. The seal housing and seal are identical to those used on the NPE.

CROSS SECTION OF NPO

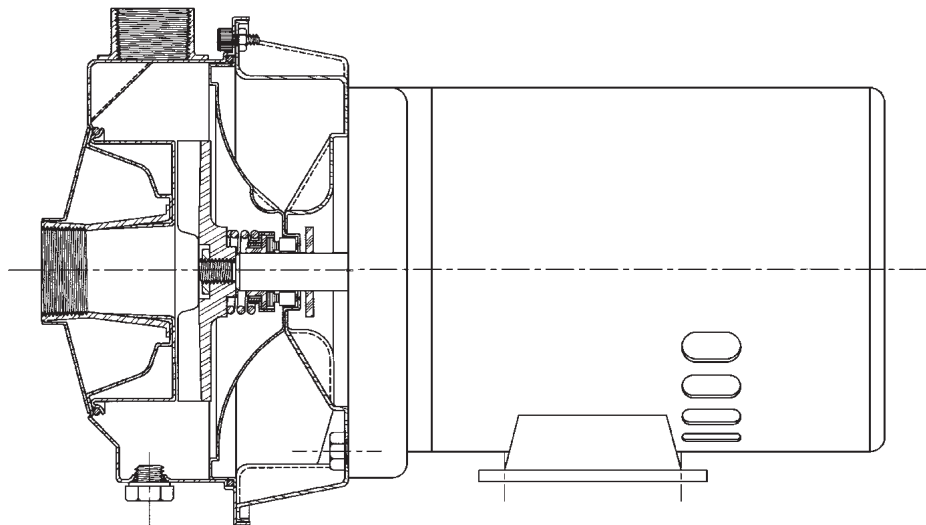

MAJOR COMPONENTS

CASING: The NPO casing is 316L stainless steel with 1¼", 1½" or 2" suction and 1", 1¼" or 1½" discharge. Connections are centerline NPT threaded. The inner flat running surface matches the maximum impeller diameter. Vent/prime and drain connections are fitted with stainless steel plugs.

SEAL HOUSING: The NPO seal housing is the same as that used for the NPE. It is made of 316L stainless and features a series of formed barriers designed to keep the liquid circulating and reduce the chance of heat build up in the seal area. The seal stationary seat fits into the opening. The seal housing also positions the casing o-ring against the casing rim.

SEALS: John Crane, Type 21, 5/8" seals are used in the NPO. The standard seal is carbon/silicon-carbide/viton. Optional faces are silicon-carbide vs. silicon-carbide. Optional elastomer is EPR. Metal parts are all 316 stainless steel. Seals are interchangeable with the NPE. Casing o-rings are available to match seal elastomer options.

IMPELLER: The NPO impeller uses a semi-open design, with no front shroud. This type of impeller is capable of passing up to 3/8" solids and is ideal for applications where food particles, lint, seeds or other small solids and particles are likely to be found in the pumpage. The NPO impeller is 316 stainless steel for maximum service life. It is threaded to fit 56J motor shafts and is supplied with a front lock nut.

MOTOR ADAPTER: The NPO is supplied as standard, with a non-footed 316L stainless steel motor adapter. This is the same motor adapter used on the frame mounted version of the NPE. This design was chosen to provide less vibration and more mounting standardization through the use of welded motor mounting feet. Please note, however, that this version produces an interference fit, since the casing extends approximately 1 1/8" below the motor feet. In most washing systems, the pump is mounted on framing inside the cabinet so that the liquid end is located in open space. The footed NPE motor adapter with a non-footed motor can be ordered as an option if required.

MOTORS: The most common motor for the NPO is a single phase, ODP, 115/230 volt with a solid state switch. This motor is available in ½ to 2 HP and is typical in most washer systems. In addition, those motors used for the ICS including ODP, TEFC, Explosion Proof, 575 volt and three phase may also be used on the NPO. The use of NPE motors is also possible, but requires the use of the footed motor adapter.

VENT/FLUSH: The optional vent/seal flush for the NPE is also available on the NPO. This is particularly useful in removing air bubbles which may form at the seal area during priming if the pump is mounted vertically.

FRAME MOUNTED: The NPO can be frame mounted if required by using the same bearing frame, baseplate, coupling and T-frame motors used for the NPE.

NPO PRODUCT LINE NUMBERING SYSTEM

The various versions of the NPO are identified by a product code number on the pump label. This number is also the catalog number for the pump. The meaning of each digit in the product code number is shown below.

EXAMPLE PRODUCT CODE

1 SN 2 C 1 A 4 F R

Casing Rotation, Optional

R = 3 o'clock B = 6 o'clock L = 9 o'clock

NOTE: Rotation when viewed from suction end of pump.
Standard discharge position is 12 o'clock.

Seal Vent/Flush Option

Mechanical Seal and O-ring

4 = Pre-engineered standard

For optional mechanical seal modify catalog order no. with seal code listed below.

| John Crane Type 21 Mechanical Seal (5/8" seal) | | | | | | |
|--|---------|-------------|------------|-------------|----------|---------------|
| Seal Code | Rotary | Stationary | Elastomers | Metal Parts | Part No. | Casing O-Ring |
| 2 | Carbon | Sil-Carbide | EPR | 316 SS | 10K18 | EPR |
| 4 | | | Viton | | 10K55 | Viton |
| 5 | Carbide | | EPR | | 10K81 | EPR |
| 6 | | | Viton | | 10K62 | Viton |

Impeller Option . . . No Adder Required

For optional impeller diameters modify catalog order no. with impeller code listed. Select optional impeller diameter from pump performance curve.

| Impeller Code | Pump Size | | |
|---------------|---------------------------|-------------------------------|---------------------------|
| | 1 x 1 1/4 - 6 Diameter | 1 1/4 x 1 1/2 - 6 Diameter | 1 1/2 x 2 - 6 Diameter |
| A | 4 5/16 | 5 5/16 | 5 7/16 |
| B | 4 | 5 1/16 | 5 1/4 |
| C | 3 3/4 | 4 5/8 | 4 15/16 |
| D | 3 1/2 | 4 3/16 | 4 5/8 |
| E | 3 1/4 | 4 1/16 | 4 7/16 |
| F | 3 | 3 3/4 | 4 3/16 |
| G | 5 3/8 | 3 7/16 | 3 3/4 |
| H | 5 | - | - |

Driver

1 = 1 PH, ODP 4 = 1 PH, TEFC 7 = 3 PH, XP
 2 = 3 PH, ODP 5 = 3 PH, TEFC 8 = 575 V, XP
 3 = 575 V, ODP 6 = 575 V, TEFC 0 = 1 PH, XP

HP Rating

C = 1/2 HP E = 1 HP G = 2 HP J = 5 HP
 D = 3/4 HP F = 1 1/2 HP H = 3 HP K = 7 1/2 HP

Driver: Hertz/Pole/RPM

1 = 60 Hz, 2 pole, 3500 RPM
 2 = 60 Hz, 4 pole, 1750 RPM
 4 = 50 Hz, 2 pole, 2900 RPM
 5 = 50 Hz, 4 pole, 1450 RPM

Material

SN = Stainless steel

Pump Size

1 = 1 x 1 1/4 - 6 2 = 1 1/4 x 1 1/2 - 6 3 = 1 1/2 x 2 - 6

For frame mounted version, substitute the letters "FRM" in these positions.

COMMON NPO CATALOG MODELS

| GPM | Head (Feet) | HP | Single Phase | | Three Phase | | |
|-----|-------------|----|--------------|----------|-------------|----------|----------|
| | | | ODP* | TEFC | ODP | TEFC | XP |
| 10 | 37 | ½ | 1SN1C1D4 | 1SN1C4D4 | 1SN1C2D4 | 1SN1C5D4 | 1SN1C7D4 |
| | 43 | ½ | 1SN1C1C4 | 1SN1C4C4 | 1SN1C2C4 | 1SN1C5C4 | 1SN1C7C4 |
| | 50 | ½ | 1SN1C1B4 | 1SN1C4B4 | 1SN1C2B4 | 1SN1C5B4 | 1SN1C7B4 |
| | 58 | ¾ | 1SN1D1A4 | 1SN1D4A4 | 1SN1D2A4 | 1SN1D5A4 | 1SN1D7A4 |
| 20 | 35 | ½ | 1SN1C1D4 | 1SN1C4D4 | 1SN1C2D4 | 1SN1C5D4 | 1SN1C7D4 |
| | 40 | ½ | 1SN1C1C4 | 1SN1C4C4 | 1SN1C2C4 | 1SN1C5C4 | 1SN1C7C4 |
| | 46 | ¾ | 1SN1D1B4 | 1SN1D4B4 | 1SN1D2B4 | 1SN1D5B4 | 1SN1D7B4 |
| | 54 | 1 | 1SN1E1A4 | 1SN1E4A4 | 1SN1E2A4 | 1SN1E5A4 | 1SN1E7A4 |
| 30 | 32 | ¾ | 1SN1C1D4 | 1SN1C4D4 | 1SN1C2D4 | 1SN1C5D4 | 1SN1C7D4 |
| | 37 | ¾ | 1SN1C1C4 | 1SN1C4C4 | 1SN1C2C4 | 1SN1C5C4 | 1SN1C7C4 |
| | 43 | 1 | 1SN1E1B4 | 1SN1E4B4 | 1SN1E2B4 | 1SN1E5B4 | 1SN1E7B4 |
| | 50 | 1½ | 1SN1F1A4 | 1SN1F4A4 | 1SN1F2A4 | 1SN1F5A4 | 1SN1F7A4 |
| 40 | 27 | 1 | 1SN1E1D4 | 1SN1E4D4 | 1SN1E2D4 | 1SN1E5D4 | 1SN1E7D4 |
| | 33 | 1 | 1SN1E1C4 | 1SN1E4C4 | 1SN1E2C4 | 1SN1E5C4 | 1SN1E7C4 |
| | 38 | 1½ | 1SN1F1B4 | 1SN1F4B4 | 1SN1F2B4 | 1SN1F5B4 | 1SN1F7B4 |
| | 46 | 1½ | 1SN1F1A4 | 1SN1F4A4 | 1SN1F2A4 | 1SN1F5A4 | 1SN1F7A4 |
| 50 | 24 | 1 | 1SN1E1D4 | 1SN1E4D4 | 1SN1E2D4 | 1SN1E5D4 | 1SN1E7D4 |
| | 29 | 1½ | 1SN1F1C4 | 1SN1F4C4 | 1SN1F2C4 | 1SN1F5C4 | 1SN1F7C4 |
| | 35 | 1½ | 1SN1F1B4 | 1SN1F4B4 | 1SN1F2B4 | 1SN1F5B4 | 1SN1F7B4 |
| | 42 | 1½ | 1SN1F1A4 | 1SN1F4A4 | 1SN1F2A4 | 1SN1F5A4 | 1SN1F7A4 |
| 60 | 20 | 1½ | 1SN1F1D4 | 1SN1F4D4 | 1SN1F2D4 | 1SN1F5D4 | 1SN1F7D4 |
| | 25 | 1½ | 1SN1F1C4 | 1SN1F4C4 | 1SN1F2C4 | 1SN1F5C4 | 1SN1F7C4 |
| | 30 | 1½ | 1SN1F1B4 | 1SN1F4B4 | 1SN1F2B4 | 1SN1F5B4 | 1SN1F7B4 |
| | 37 | 2 | 1SN1G1A4 | 1SN1G4A4 | 1SN1G2A4 | 1SN1G5A4 | 1SN1G7A4 |
| 70 | 16 | 1½ | 1SN1F1D4 | 1SN1F4D4 | 1SN1F2D4 | 1SN1F5D4 | 1SN1F7D4 |
| | 21 | 1½ | 1SN1F1C4 | 1SN1F4C4 | 1SN1F2C4 | 1SN1F5C4 | 1SN1F7C4 |
| | 25 | 1½ | 1SN1F1B4 | 1SN1F4B4 | 1SN1F2B4 | 1SN1F5B4 | 1SN1F7B4 |
| | 32 | 2 | 1SN1G1A4 | 1SN1G4A4 | 1SN1G2A4 | 1SN1G5A4 | 1SN1G7A4 |

* Single phase ODP motors have a solid state switch.

COMPONENTS AND MATERIALS OF CONSTRUCTION

GENERAL DESCRIPTION: 316 stainless steel end-suction centrifugal pump with semi-open impeller. Performance from 10-250 GPM with 20-110 feet TDH. Maximum working pressure is 125 PSIG (9 bars). Standard liquid temperatures to 212° F (100° C) with the standard seal or 250° F (121° C) with the optional high temperature seal. Solids handling to 3/8". Suction and discharge connections are NPT threaded with the suction at 1 1/4", 1 1/2" or 2" and the discharge at 1", 1 1/4" or 1 1/2".

COMPONENT

MATERIALS OF CONSTRUCTION

| | |
|---------------------------|--|
| Casing | AISI 316L Stainless Steel |
| Impeller | AISI 316 Stainless Steel |
| Motor Adapter | AISI 316L Stainless Steel |
| Seal Housing | AISI 316L Stainless Steel |
| Casing Socket Head Screws | AISI 430 Stainless Steel |
| Casing O-Ring | Viton |
| Casing Vent Plug | AISI 316L Stainless Steel with Viton O-Ring |
| Casing Drain Plug | AISI 316L Stainless Steel with Viton O-Ring |
| Motor Bolts | Plated Steel |
| Deflector | BUNA |
| Mechanical Seal | Standard with Carbon vs. Silicon-Carbide, 316 Stainless Steel Metal Parts and Viton Elastomers |
| Impeller Lock Nut | 316 Stainless Steel |

MOTORS: NEMA standard 56J frame with rigid base and ball bearing design stainless steel shaft. Available enclosures include open-drip proof, totally enclosed-fan cooled and explosion proof. Motors are 50/60 Hz, 3500 RPM single phase (115/230V) or three phase (208-230/460V or 575V). Horsepowers are 1/2 to 7 1/2" HP. Single phase motors have built in overload with auto reset. Three phase motors require starter and heaters which may be ordered separately.

PERFORMANCE

The following curves show the performance of the three signs of NPO when operating at 3500 RPM.

IMPORTANT NOTE:

The NPO performance is very dependant on the clearance between the impeller and casing face plate. The curves show the worst case performance with NPO motors. Individual pumps may produce up to 5 feet of additional TDH. Use of other motors may result in lower performance. Contact Goulds Water Technology customer service for help in selecting a pump for a specific OEM application.

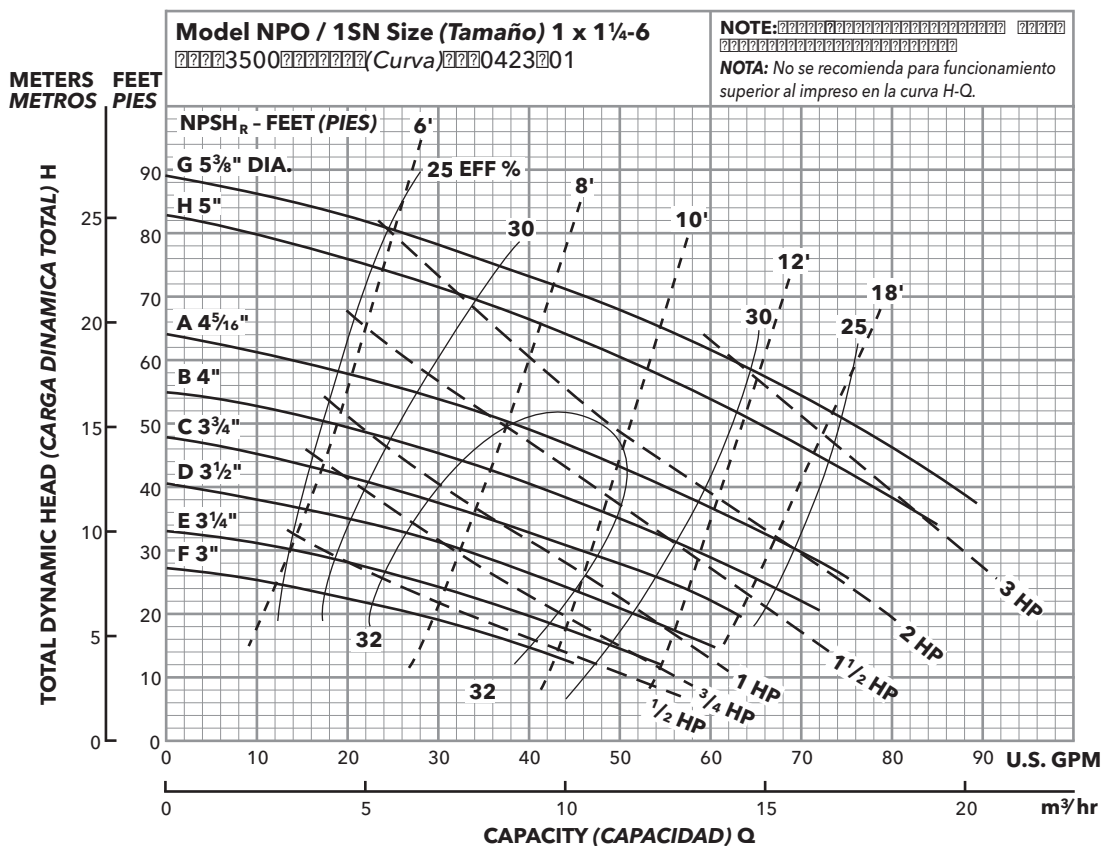

PERFORMANCE

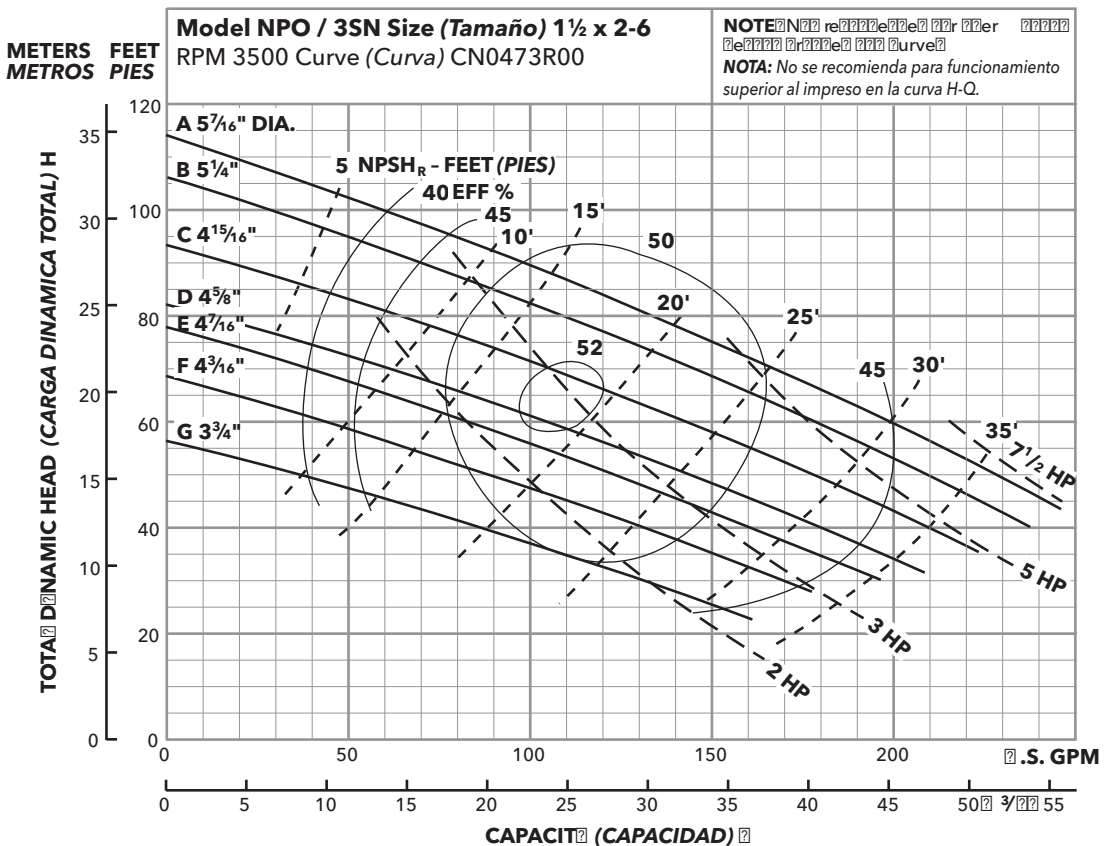
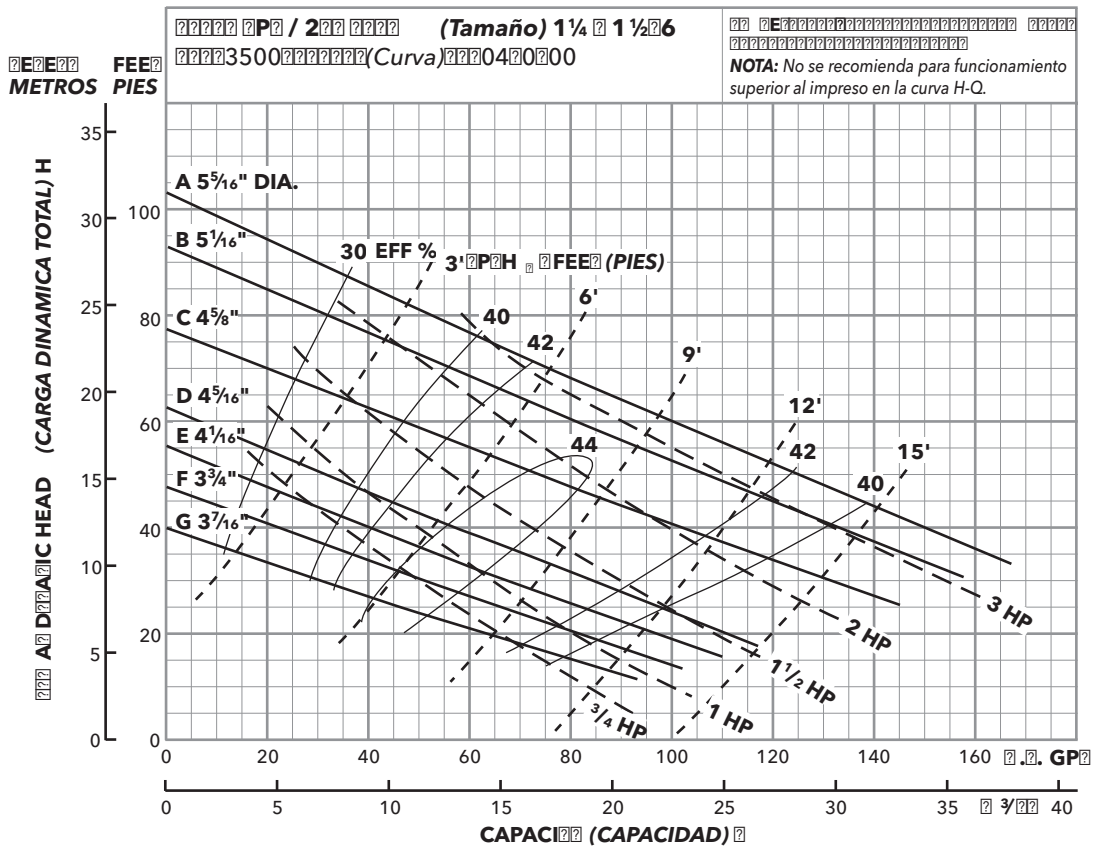

PERFORMANCE

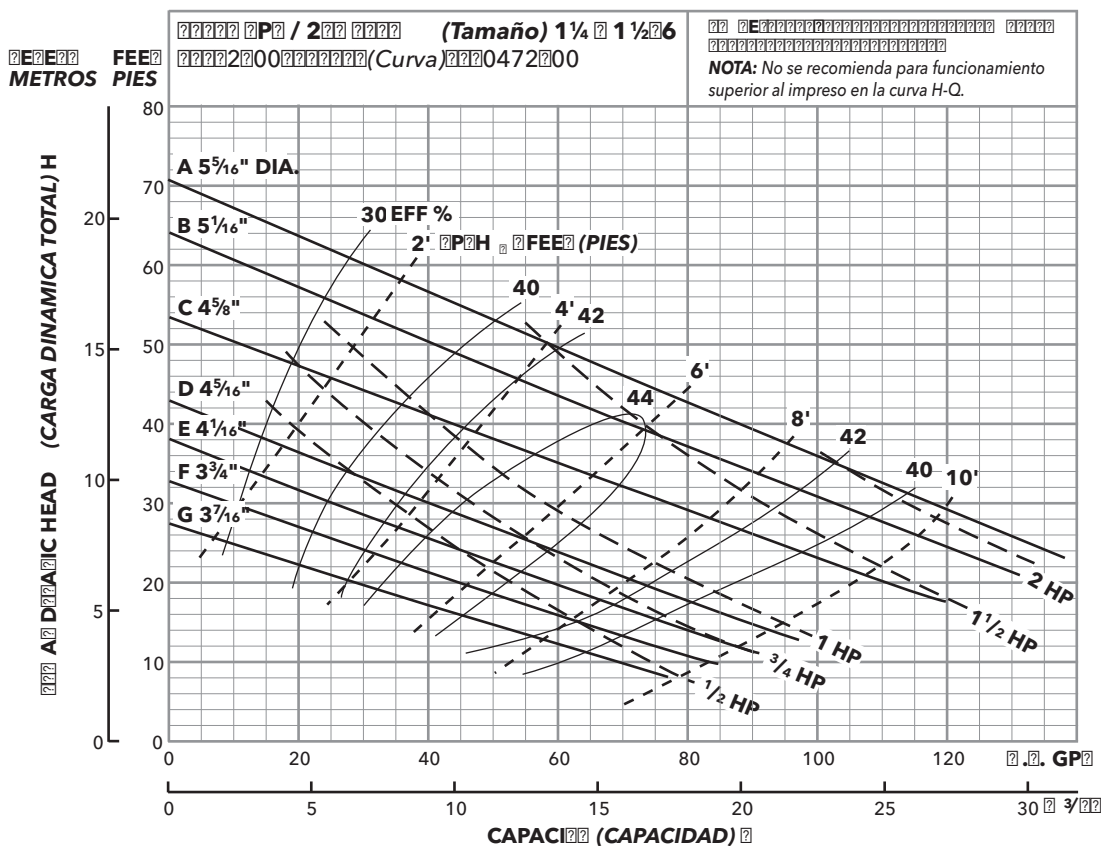
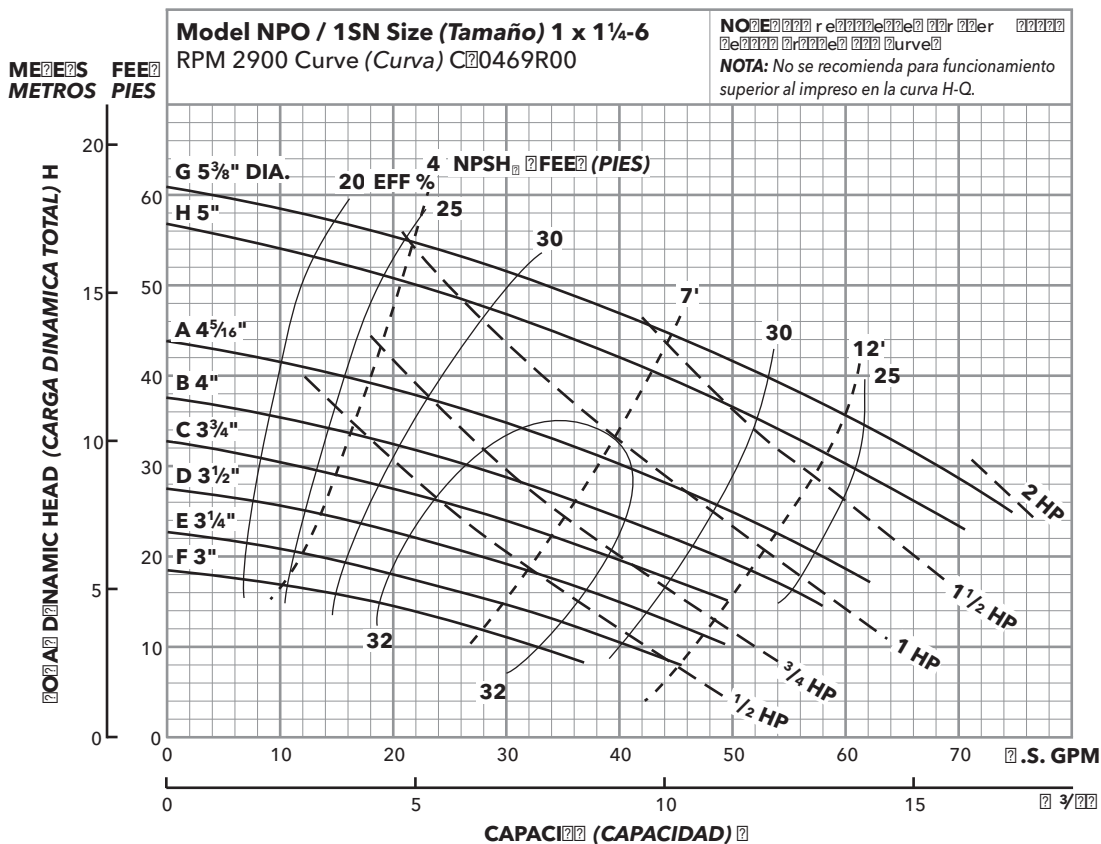

PERFORMANCE

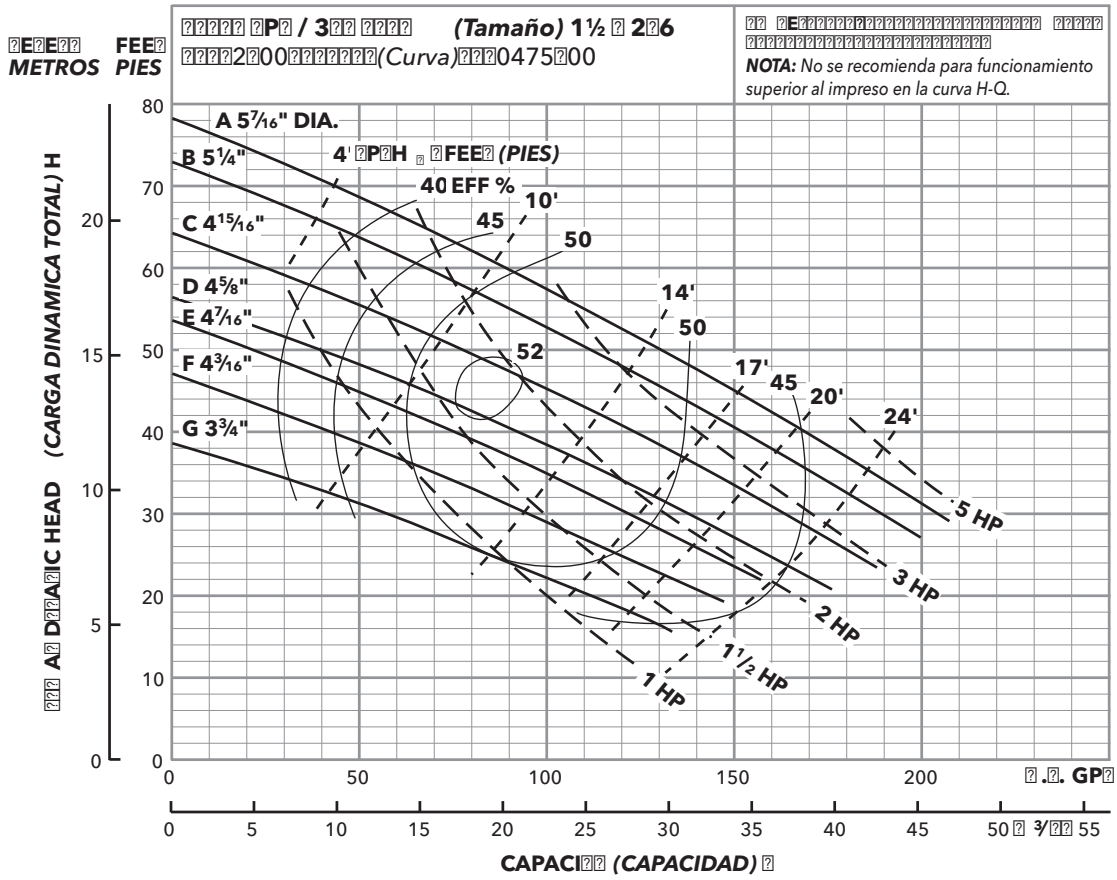

PRIMARY APPLICATIONS

Applications for the NPO are generally identified by a need to handle small solids and particulate in combination with detergents. These applications will typically see the benefits of stainless steel construction and open impeller design.

Examples of such applications include:

- Commercial Dishwashers
- Commercial Laundry Systems
- Parts Washers
- Machine Tool Coolant Recirculation
- Circulating Systems for Detergents, Degreasers and Lubricating Oils

Most of these applications are characterized by high OEM business, with potential being evenly split between new systems and replacement pumps for existing installations. In both cases, the sale will be primarily through the OEM organization.

The following pages provide information on several example applications to help you identify potential OEM accounts for the NPO in your area. Your Goulds Water Technology Regional Sales Manager, and Goulds Water Technology Applications Engineering can help you in working with OEM prospects. Evaluation of the entire OEM system should be done before recommending a specific model.

The following S.I.C. numbers can be used to help you locate NPO prospects. Use these with either your Goulds Water Technology database or local industrial directory.

| SIC# | ACCOUNT TYPE |
|-------------|---|
| 3561 | Parts washers and machine tool coolant |
| 3582 | Commercial laundry and cleaning systems |
| 3589 | Commercial Dishwashers |

DISHWASHER MARKET

The Dishwasher Market for the NPO is composed of those companies which manufacture commercial dishwashers for use in restaurants, bars and cafeterias in various types of institutions. This is not the same as the residential dishwasher market, which uses considerably smaller pumps.

The commercial dishwasher market in North America is about 20,000 pumps per year. Companies which manufacture these dishwashers are typically in one of two businesses: Chemical or restaurant supply. The differences between these two types of companies have a lot to do with how they view their product and the pump which goes into it.

CHEMICAL COMPANIES

Chemical Companies which produce commercial detergents may also manufacture dishwashers. The dishwasher is usually designed to maximize the effectiveness of the company's detergents and is often leased or rented as a part of a purchase agreement for the detergents. This may also involve either direct or contracted service from the company to fix customer machines.

Due to this, the chemical company is often very interested in the quality and reliability of the pump. Pricing is important, but usually less important than minimizing service time. The more the machine is running, the more detergent will be used! Key benefits of the NPO are:

- Complete stainless steel construction for resistance to detergents, plus a cleaner overall package since most of the other components are also stainless.
- Open impeller design for small solids handling.
- Centerline discharge and casing rotation for easy plumbing.
- Local inventory and support from the distributor.
- Local technical help across the country and around the world.

RESTAURANT SUPPLY

These companies are primarily in business to sell hardware. Some may distribute a line of detergents, but they don't make them. In addition to washers, they may also manufacture cabinets, tables, refrigerators and ovens.

DISHWASHER MARKET

Since most of the profit for such companies needs to be made on the initial sale of the washer, cost of manufacture is much more important than it would be to the chemical company. Despite this, these companies are good prospects for an NPO, because it gives them a competitive advantage. Almost all dishwasher pumps are presently cast iron. Some manufacturers have put in plated or stainless impellers to try to improve pump life, but until now, the cost of a completely stainless pump was much too high to justify in this application. The NPO is the first completely stainless pump to meet the performance and solids handling need and still be within the general cost range of cast iron bronze fitted pumps. Key benefits of the NPO are:

- The all stainless design of the NPO gives these companies a competitive advantage since stainless is much more resistant to the detergents and chlorides used in dishwashing.
- Pump maintenance time and costs are reduced.
- Overall system costs/market prices can be kept in line while growing market share.
- All of the other benefits of the NPO covered for the chemical companies on the previous page.

TYPICAL DISHWASHER DESIGN

Most commercial dishwashers are open stainless steel cabinets designed to accommodate standard sizes of dishwasher racks. One or more spray wands are located at the top or bottom of the cabinet and a drain is at the bottom.

The dishwasher runs in two cycles: detergent wash and clean water rinse. Often, the rinse water is reused with detergent for the next machine cycle. Water temperature is 140° - 180° F and may be heated internally or by another source in the building. The cost of hot water is important to operation, which is why the rinse water is reused.

Due to the electrical power normally found in a restaurant and the humid conditions inside the washer cabinet, a single phase 115V motor with solid state switch is often used.

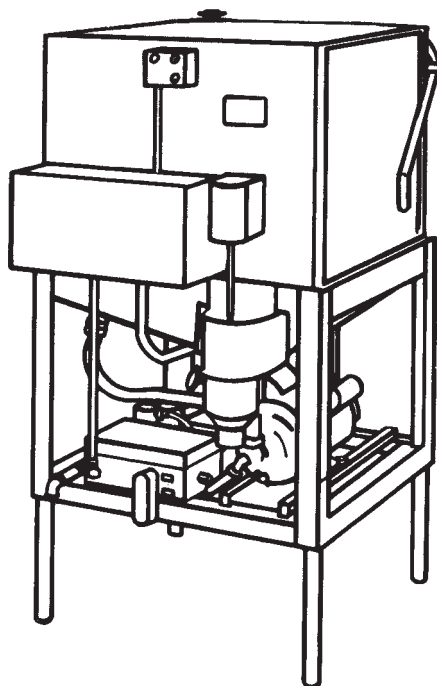

DISHWASHER MARKET

Pot and pan washers and glass washers also fall into this market area. Pot washers may demand a higher pressure than the NPO can provide, but they are good prospects for an SSH. Glass washers are becoming more popular as an appliance for bars due to the increase in sanitary regulations. These units are designed to fit under the bar and are good prospects for the NPO.

COMMERCIAL LAUNDRY

Commercial clothes washing equipment is another good application for the NPO. These systems are typically set up as a series of wash and rinse stations with one pump per station. Due to the detergents, chlorine bleaches, fabric softeners and other chemicals used in these systems, stainless steel is the preferred material for all components exposed to the liquid. In addition, most systems have several filters to remove lint. Despite this, the pump is usually exposed to a fair amount of lint and dirt which can clog up impeller vanes. To avoid this problem, an open impeller is preferred.

A variation of the standard systems involves ozone injection to reduce the amount of detergents needed to clean the clothes. NPE pumps with viton elastomers are already being used in this service since the lint would not enter the ozone injection system.

Larger versions of dry cleaning and laundromat type machines may also be prospects for the NPO, although many use smaller pumps.

Primary benefits of the NPO in commercial laundry applications include:

- Reduced maintenance due to elimination of lint clogs.
- Chemical resistance of 316L stainless steel and 316 cast pump components.
- Lower cost and lighter weight than typical cast stainless alternatives.

DISHWASHER MARKET

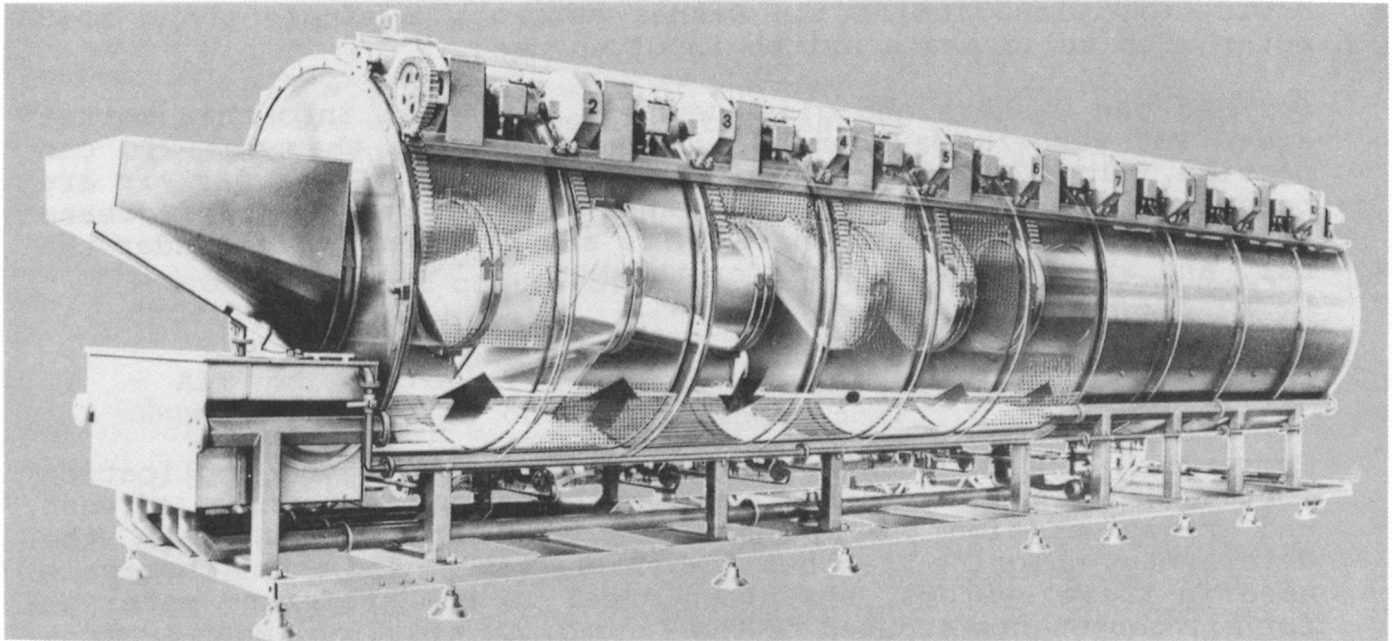

Cutaway view of double drum CBW

PARTS WASHERS

Another market which could use the benefits of both stainless steel and open impellers is parts washing. These systems are used in manufacturing companies to remove chips, dust, oils and other residue from finished parts. Machined parts are good examples of components which are usually washed after manufacture.

Typically, these systems use various chemical detergents and solvents under pressure to clean the part. The detergent is then strained to remove chips and residue, then returned to the pump for recycling. Depending on how good the straining process is, the pump may still see some fairly large particles. An open impeller design allows any residual material to pass and avoids potential damage to the pump.

Although the durability of stainless steel is an advantage in the detergent environment of a parts washer, the standard pump is typically cast iron due to traditional stainless costs. The NPO in stainless steel increases pump life, matches the materials commonly used for the rest of the unit and eliminates the chance of rust contaminants in the system.

DISHWASHER MARKET

Typical Parts Washer

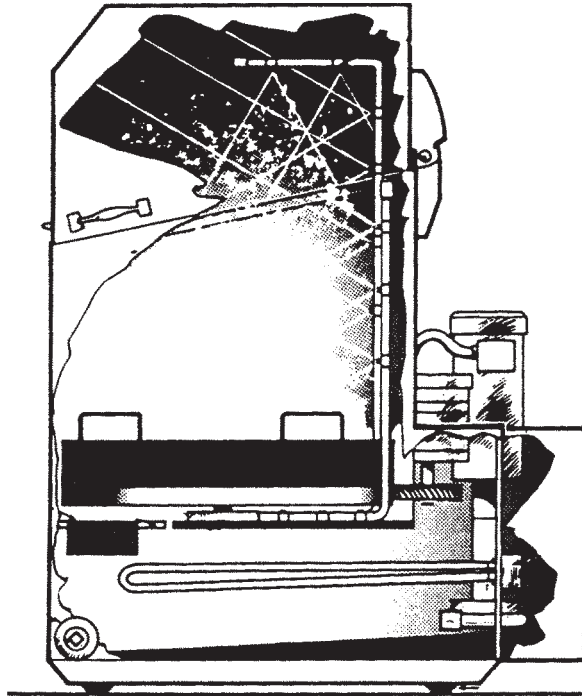

MACHINE TOOL COOLANT

A similar application can be found in the machining process itself. Coolant or machining oil is recirculated through the machining center to aid the metal cutting process. This recirculation often brings excess chips or filing into the pump. The 316 cast open impeller of the NPO can easily handle these particles with very little chance of damage or wear.

COMPETITION

NPO competition can best be analyzed by market segment. Since there are no other stainless steel open impeller pumps sold into these markets, competition comes from a variety of cast iron pumps.

Dishwashers

The primary competitor in this business is Flowserve (IDP), which sells their standard line of cast iron pumps with enclosed impellers. Some special casings have been designed to fit the pump and piping into the space available. The primary reason for their success has been direct pricing from the factory.

Advantages of the NPO over the IDP product are:

1. All Stainless Steel Design:

- Resists rust and corrosion from detergents for longer pump life.
- Eliminates chance of rust in the wash water during the first cycle of the day.
- Matches material used for other washer components for cosmetic appeal.
- More likely to pass increasingly restrictive sanitary standards.

2. Open Impeller

- Passes up to $\frac{3}{8}$ " solids including food particles, seeds, pits, small bones and other material which may have been left on the dishes.
- Eliminates pump cleaning and maintenance due to impeller clogs.

3. Centerline Discharge

- Permits up to 16 casing positions to match piping and space requirements.
- Allows standard pump models to be used for a wide variety of dishwasher models.

4. Local Stock and Support

- Goulds Water Technology distributor stock of product near the factory assures just-in-time delivery without excessive inventory.
- Goulds Water Technology distributor sales and engineering help is nearby for fast on-site assistance.

Commercial Laundry

Competition in this market is from a variety of open impeller pumps made of bronze fitted or all bronze materials. Due to traditional cast stainless costs, most pumps in this application have not been stainless steel. There are no clear leaders in terms of pump brand. Decisions are usually based on availability, chemical resistance, lint handling, overall reliability and cost. Benefits listed under dishwashers also pertain to laundry, but since most are already using an open impeller pump, this will not be seen as a competitive advantage. Resistance to corrosion and cosmetic appeal of stainless will be the biggest selling features in this market.

Parts Washer and Machine Tool

These two segments are currently served by our NPE, SSH and SSV products. The primary benefit of the NPO will be in applications where the liquid is not well filtered and the pump must handle particles and small solids. Since most of the competitive products are not open impeller designs, they are less forgiving in these situations. In addition, many of these pumps are cast iron, so the potential corrosion and cosmetic benefits of the NPO will apply.

INSTALLATION PROCEDURES

1.0 IMPORTANT

- 1.1 Inspect unit for damage. Report any damage to carrier/dealer immediately.
- 1.2 Electrical supply must be a separate branch circuit with fuses or circuit breakers, wire sizes, etc., per National and Local electrical codes. Install an all-leg disconnect switch near pump.

⚠ CAUTION ALWAYS DISCONNECT ELECTRICAL POWER WHEN HANDLING PUMP OR CONTROLS.

- 1.3 Motors must be wired for proper voltage. Motor wiring diagram is on motor nameplate. Wire size must limit maximum voltage drop to 10% of nameplate voltage at motor terminals or motor life and pump performance will be lowered.
- 1.4 Always use horsepower-rated switches, contactors and starters.

1.5 Motor Protection

- 1.5.1 **Single-Phase:** Thermal protection for single-phase units is usually built-in (check motor nameplate). If no built-in protection is provided, use contractor with a proper overload. Fusing is permissible.
- 1.5.2 **Three-Phase:** Provide three-leg protection with properly sized magnetic starter and thermal overloads.

1.6 Maximum Operating Limits

| | |
|---------------------|---|
| Liquid Temperature: | 212° F (100° C) with standard seal |
| | 250° F (120° C) with high temperature seal option |
| Pressure: | 150 PSI |
| Starts Per Hour: | 20 |

- 1.7 Regular inspection and maintenance will increase service life. Base schedule on operating time. Refer to section 8.

2.0 GENERAL

2.1

- 2.1.1 Locate pump as near liquid source as possible (below level of liquid for automatic operation).
- 2.1.2 Protect from freezing or flooding.
- 2.1.3 Allow adequate space for servicing and ventilation.
- 2.1.4 All piping must be supported independently of the pump and must "line-up" naturally.

⚠ CAUTION NEVER DRAW PIPING INTO PLACE BY FORCING THE PUMP SUCTION AND DISCHARGE CONNECTIONS.

- 2.1.5 Avoid unnecessary fittings. Select sizes to keep friction losses to a minimum.
- 2.1.6 Units may be installed horizontally, inclined or vertically. For vertical installation, the optional seal vent is recommended to eliminate potential air entrapment during start-up.

⚠ CAUTION DO NOT INSTALL WITH MOTOR BELOW PUMP. ANY LEAKAGE OR CONDENSATION WILL AFFECT THE MOTOR.

INSTALLATION PROCEDURES

2.1.7 Foundation must be flat and substantial to eliminate strain when tightening bolts. Use rubber mounts to minimize noise and vibration.

2.1.8 Tighten motor hold down bolts before connecting piping to plumbing.

3.0 SUCTION PIPING

3.1 Low static suction lift and short, direct suction piping is desired. For suction lift over 10 feet and liquid temperatures over 120° F, consult pump performance curve for Net Positive Suction Head required.

3.2 Suction pipe must be at least as large as the suction connection of the pump. Smaller size will degrade performance.

3.3 If larger pipe is required, an eccentric pipe reducer (with straight side up) must be installed at the pump.

3.4 Installation with pump below source of supply

3.4.1 Install full flow isolation valve in piping for inspection and maintenance.

⚠ CAUTION DO NOT USE SUCTION ISOLATION VALVE TO THROTTLE PUMP.

3.5 Installation with pump above source of supply

3.5.1 Avoid air pockets. No part of piping should be higher than pump suction connection. Slope piping upward from liquid source.

3.5.2 All joints must be airtight.

3.5.3 Foot valve to be used only if necessary for priming or to hold prime on intermittent service.

3.5.4 Suction strainer open area must be at least triple the pipe area.

3.6 Size of inlet from liquid source and minimum submergence over inlet, must be sufficient to prevent air entering pump through vortexing. See Figures 1-4.

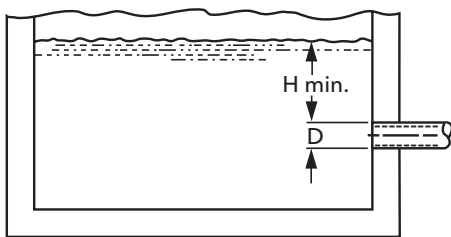

Figure 1

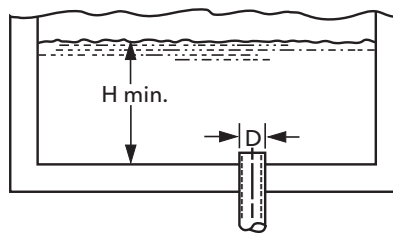

Figure 2

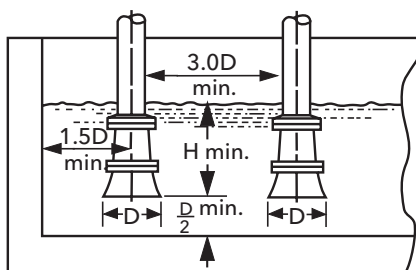

Figure 3

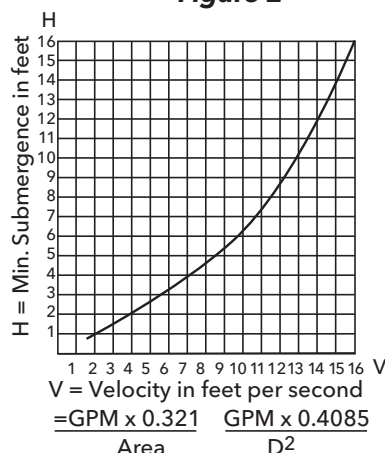

Figure 4

INSTALLATION PROCEDURES

4.0 DISCHARGE PIPING

- 4.1 Arrangement must include a check valve located between a gate valve and the pump. The gate valve is for regulation of capacity or for inspection of the pump or check valve.
- 4.2 If an increaser is required, place between check valve and pump.

5.0 ROTATION

- 5.1 Correct rotation is right-hand (clockwise when viewed from the motor end). Switch power on and off quickly. Observe shaft rotation. To change rotation:
 - 5.1.1 **Single-Phase Motor:** Non-reversible.
 - 5.1.2 **Three-Phase Motor:** Interchange any two power supply leads.

6.0 OPERATION

- 6.1 Before starting, pump must be primed (free of air and suction pipe full of liquid) and discharge valve partially open.

CAUTION PUMPED LIQUID PROVIDES LUBRICATION. IF PUMP IS RUN DRY, ROTATING PARTS WILL SEIZE AND MECHANICAL SEAL WILL BE DAMAGED. DO NOT OPERATE AT OR NEAR ZERO FLOW. ENERGY IMPARTED TO THE LIQUID IS CONVERTED INTO HEAT. LIQUID MAY FLASH TO VAPOR. ROTATING PARTS REQUIRE LIQUID TO PREVENT SCORING OR SEIZING.

- 6.2 Make complete check after unit is run under operating conditions and temperature has stabilized. Check for expansion of piping.

7.0 MAINTENANCE

- 7.1 On the close-coupled NPO unit, bearings are located in and are a part of the motor. They are permanently lubricated and no greasing is required.

8.0 DISASSEMBLY

Complete disassembly of the unit will be described. Proceed only as far as required to perform the maintenance work needed.

- 8.1 Turn off power.
- 8.2 Drain system. Flush if necessary.
- 8.3 Remove motor hold down bolts.

INSTALLATION PROCEDURES

8.4 Disassembly of liquid end

8.4.1 Remove casing bolts.

8.4.2 Remove back pullout assembly from casing.

8.4.3 Remove cap at opposite end of motor. A screwdriver slot or a pair of flats will be exposed. Use screwdriver or vise grips to stop shaft rotation.

8.4.4 Remove impeller lock nut by turning clockwise.

8.4.5 Remove impeller by turning clockwise.

8.4.6 With two pry bars 180° apart and inserted between the seal housing and the motor adapter, carefully separate the two parts. The mechanical seal rotary unit should come off the shaft with the seal housing.

8.4.7 Push out the mechanical seal stationary seat from the motor side of the seal housing.

9.0 REASSEMBLY

9.1 All parts should be cleaned before reassembly.

9.2 Refer to parts list to identify required replacement items. Specify pump catalog number when ordering parts.

9.3 Reassemble the pump in the reverse order of disassembly.

9.4 Observe the following when reassembling the liquid-end:

9.4.1 All mechanical seal components must be in good condition or leakage may result. Replacement of complete seal assembly, whenever seal has been removed, is good standard practice.

It is permissible to use a light lubricant, such as glycerin, to facilitate assembly. Do not contaminate the mechanical seal faces with the lubricant.

9.4.2 Inspect the casing o-ring and replace if damaged. This o-ring may be lubricated with petroleum jelly to ease assembly.

9.4.3 Tighten the casing bolts in a star pattern (like tightening a drum head) to apply even pressure and avoid cocking.

9.5 Check reassembled unit for binding and correct as required.

TROUBLESHOOTING

PROBLEM

Motor Not Running
 Little or No Liquid Delivered
 Power Consumption Too High
 Excessive Noise / Vibration

SEE CAUSES

1 – 6
 7 – 17
 4, 17, 18, 19, 22
 4, 6, 9, 13, 15, 16, 18, 20 – 22

CAUSES

1. Tripped thermal protector
2. Open circuit breaker
3. Blown fuse
4. Rotating parts binding
5. Motor wired improperly
6. Defective motor
7. Not primed
8. Discharge plugged or valve closed
9. Incorrect rotation
10. Foot valve too small, suction not submerged, inlet screen plugged.
11. Low voltage
12. Phase loss (three-phase only)
13. Air or gases in liquid
14. System head too high
15. NPSHA too low: Suction lift too high or suction losses excessive. Check with vacuum gauge.
16. Impeller worn
17. Incorrect impeller diameter
18. head too low causing excessive flow rate
19. Viscosity or specific gravity too high
20. Worn bearings
21. Pump piping loose
22. Pump and motor misaligned

Xylem |'zīləm|

- 1) The tissue in plants that brings water upward from the roots;
- 2) a leading global water technology company.

We're a global team unified in a common purpose: creating innovative solutions to meet our world's water needs. Developing new technologies that will improve the way water is used, conserved, and re-used in the future is central to our work. We move, treat, analyze, and return water to the environment, and we help people use water efficiently, in their homes, buildings, factories and farms. In more than 150 countries, we have strong, long-standing relationships with customers who know us for our powerful combination of leading product brands and applications expertise, backed by a legacy of innovation.

For more information on how Xylem can help you, go to www.xyleminc.com



Xylem Inc.
2881 East Bayard Street Ext., Suite A
Seneca Falls, NY 13148
Phone: (800) 453-6777
Fax: (888) 322-5877
www.gouldswatertechnology.com

Goulds is a registered trademark of Goulds Pumps, Inc. and is used under license.
© 2015 Xylem Inc. NPOPTM R1 July 2015